

Antes da
montagem
confira as peças.
**VEJA NO
VERSO**

INSTRUÇÕES DE MONTAGEM PORTA BLOCO DUPLA FACE

chave de fenda

O que você vai precisar para a instalação:



Peças de madeira:

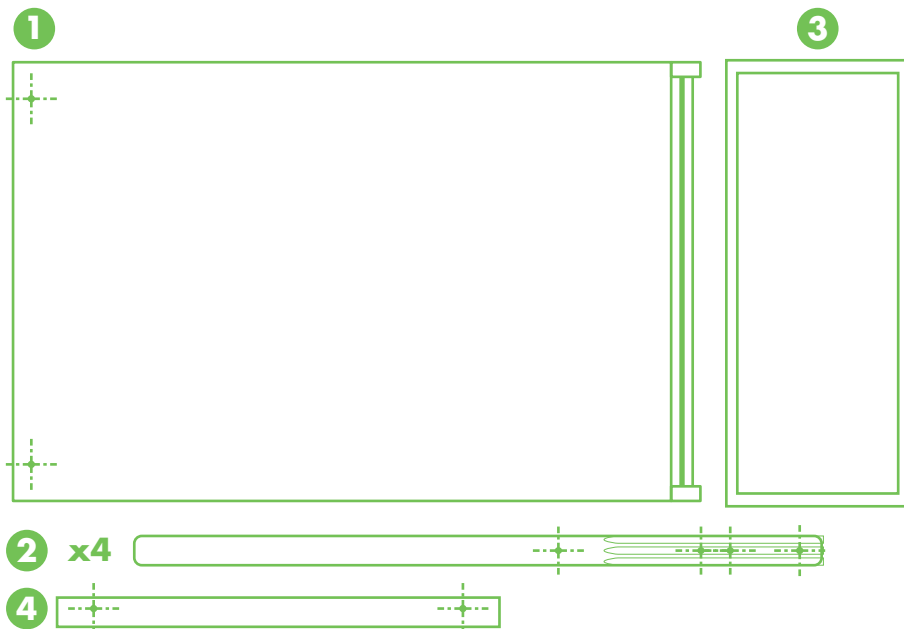

Ferragens:

Parafuso mod.: (A)

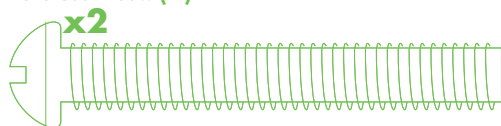

Parafuso mod.: (B)

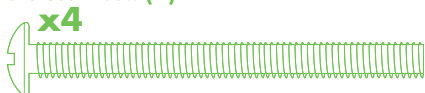

Manípulo

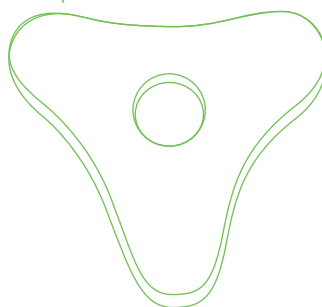

x4 pretos
x2 cinzas

INSTRUÇÕES DE MONTAGEM

Porta Bloco Dupla Face

1. Quadro (Base):

Abra o quadro e fixe as articulações.

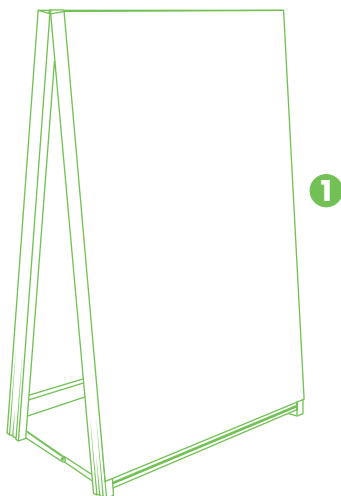

1.a Pés:

Fixe-os utilizando os parafusos (B) e manípulo preto.

Lembre-se de fixar com os chanfros da madeira de frente um para o outro.

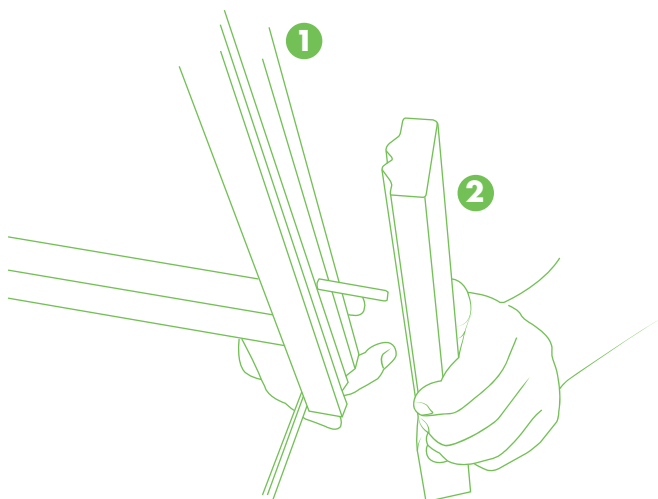

2. Encaixe a bandeja no espaço da Base
*tem espaço em ambos os lados

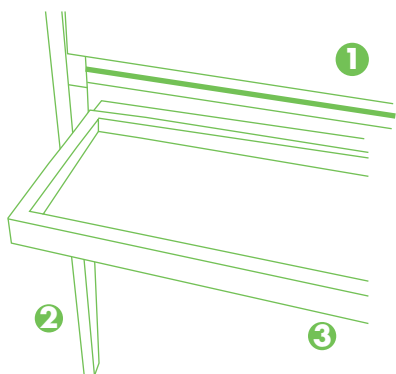

3. Prenda o suporte do bloco como na figura utilizando os parafusos (A) e os manípulos cinzas.

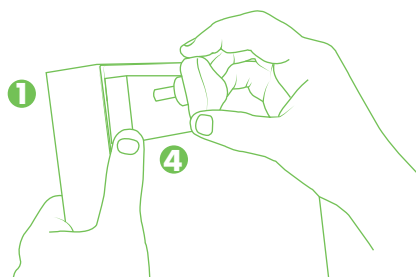

Pronto!

Seu porta bloco está montado!

