

Antes da
montagem
confira as peças.
**VEJA NO
VERSO**

INSTRUÇÕES DE MONTAGEM PORTA QUADRO DE PINTURA

O que você vai precisar para a instalação:

chave de fenda



chave Philips



chave Allen (incluso)



Kit Instalação

Confira todos os itens antes de iniciar a montagem.

Se houver itens faltantes entre em contato com nossa central de relacionamento.

Peças de madeira:

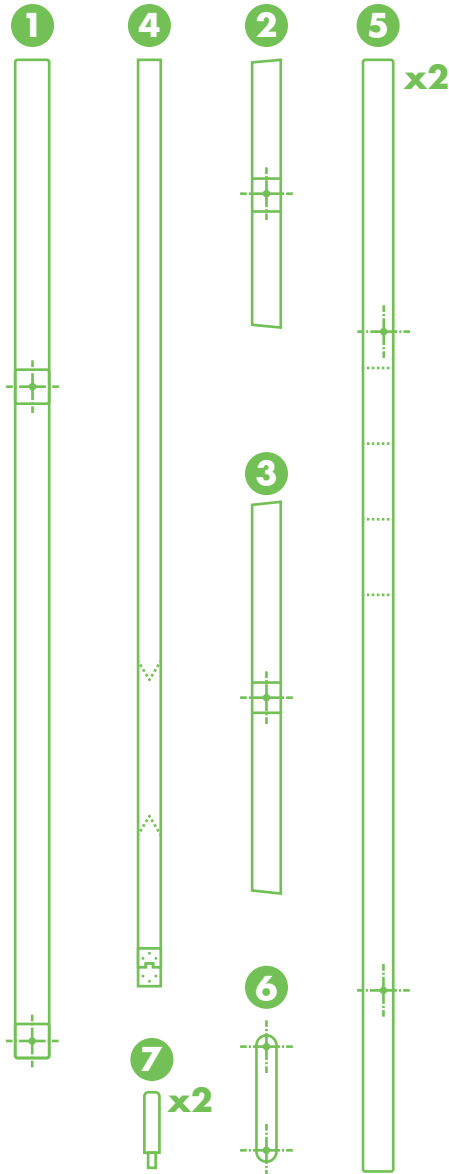

Ferragens:

Parafuso mod.: (A)

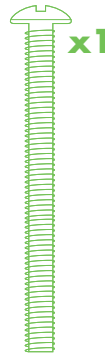

Parafuso mod.: (B)

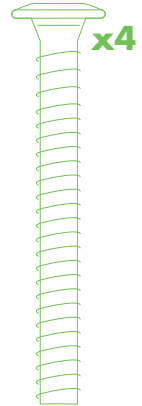

Parafuso mod.: (C)



Parafuso mod.: (D)

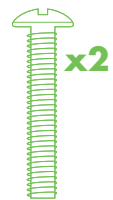

Chaveta

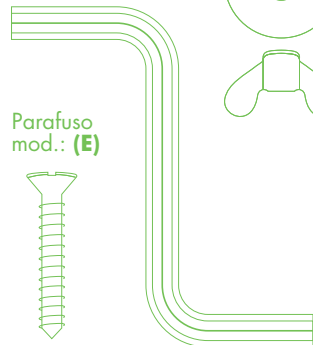

Parafuso mod.: (E)



INSTRUÇÕES DE MONTAGEM

Porta Quadro de Pintura

1. Base:

Fixar os componentes da base central (Fig. 1), utilizando o parafuso (D) na parte de baixo e um parafuso (D) na parte de cima, (note que na parte de cima não vai a arruela) (Fig. 2 e 3).

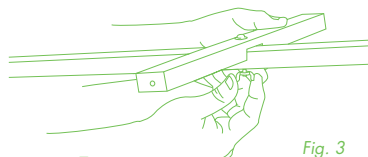
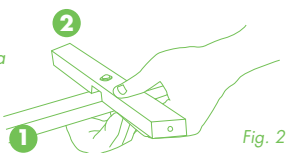
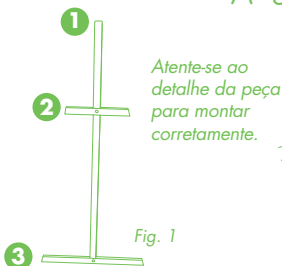

Não coloque a borboleta na parte de cima até completar o passo 2.

2. Fixar o suporte traseiro na parte superior (Fig. 4), encaixando no parafuso. Aperte a borboleta, e então coloque os dois parafusos (C) nas marcações (Fig. 5).

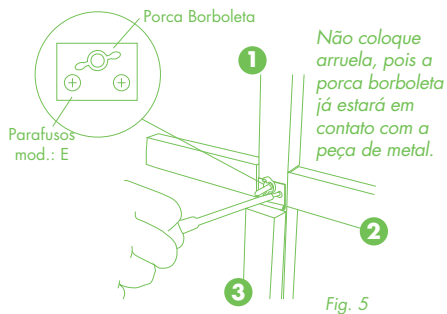
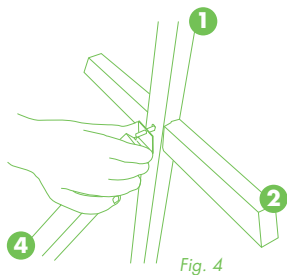

3. Fixar os suportes laterais, utilizando os parafusos (B). Verifique a posição (Fig. 7).

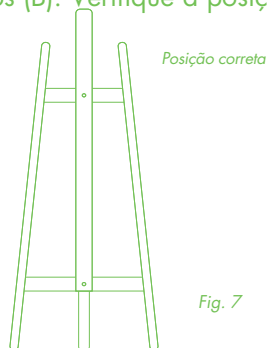
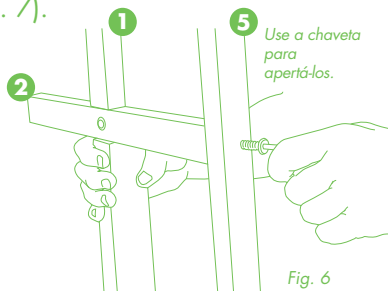

4. Fixe a haste (peça 6) responsável pelo ajuste da inclinação utilizando o parafuso (E) na parte fixa e o parafuso (A) na parte móvel, observe as marcações existente na peça 1. Ajuste a inclinação conforme o desejado (Fig. 8).

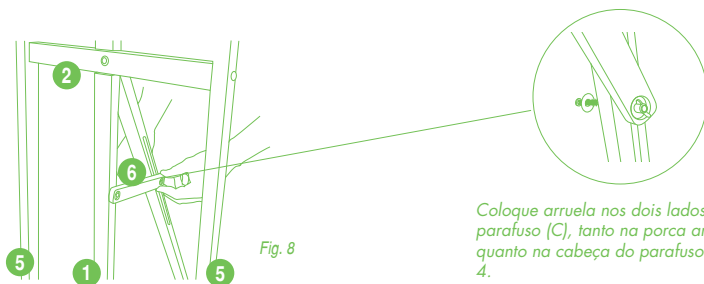

Coloque arruela nos dois lados do parafuso (C), tanto na porca arruela quanto na cabeça do parafuso na peça 4.

5. Encaixe os suportes (peça 7) do quadro ajustando a altura conforme o desejado utilizando os furos de altura nas laterais (peça 5).

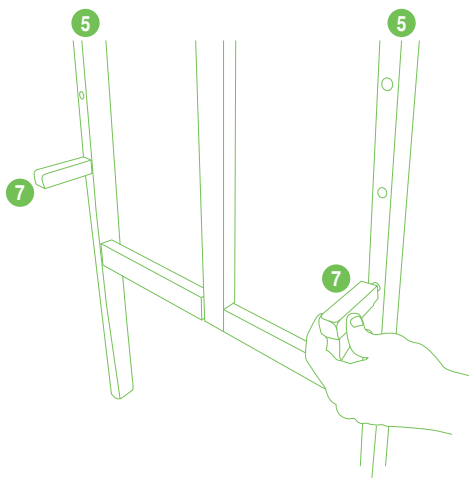

Pronto!
 Seu porta quadro de pintura já está pronto para ser utilizado.

